

PALAZZANI

d i s e g n o t e c n i c o ■ t e c h n i c a l d r a w i n g

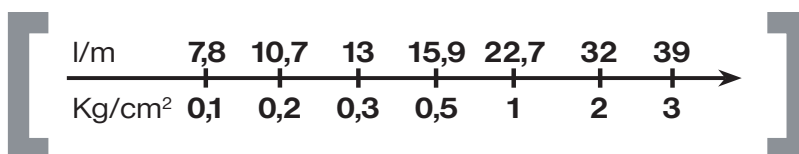
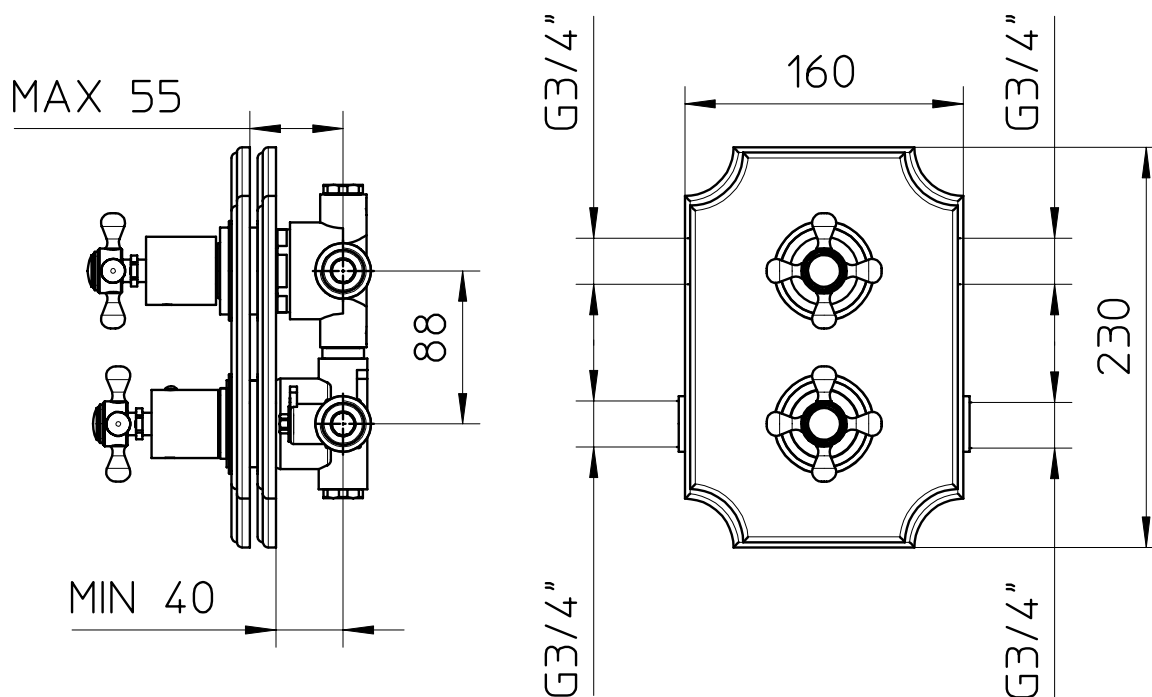

d i s e g n o t e c n i c o ■ t e c h n i c a l d r a w i n g

termostatici

512427