

# PALAZZANI

d i s e g n o   t e c n i c o   ■   t e c h n i c a l   d r a w i n g

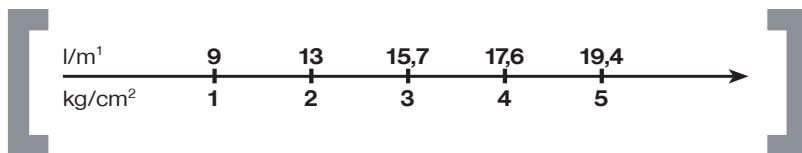
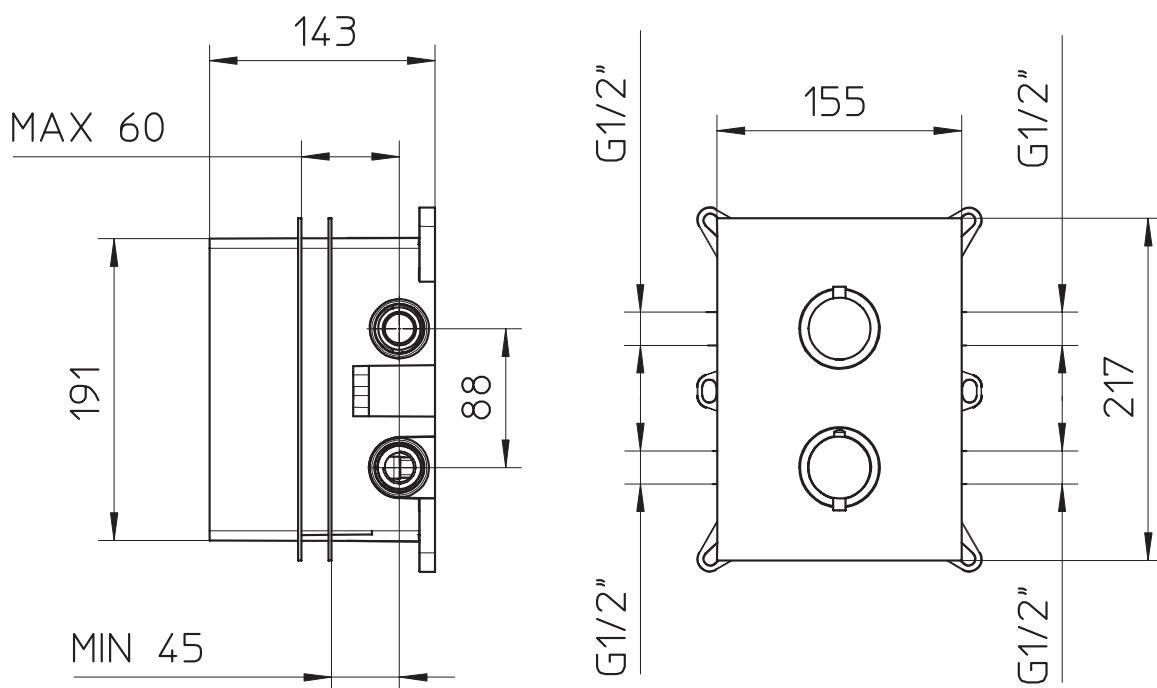

d i s e g n o   t e c n i c o   ■   t e c h n i c a l   d r a w i n g

idrotech

995709+962502